



QA16 ***Addressable System***

Operating Manual

HORING LIH INDUSTRIAL CO., LTD.

www.horinglih.com



CONTENTS



QA16 System Characteristics	1
1. LED Description and Keypad Reference	2
1.1. LED Description	2
1.2. Keypad Reference	3
2. LCD Reference	5
2.1. LCD Display Description.....	6
2.2. LCD Function Selection List Instruction	8
(1)Time Setting	8
(2)Alarm Data	8
(3)WireBreak Data	9
(4)Fault Data	9
(5)History Log	10
(6)History Log CLR	11
(7)Alarm Delay	11
(8)Download File	11
(9)Output Delay	12
(A)Status Test	12
(B)Status Review	13
(C)Printer Setting	14
(D)Loop Setting	15
(E)System Review	15
3. System Wiring Instruction	16
4. Installation and testing notes	16
5. Wiring Diagram	17
(1)Detector Wiring.....	18
(2)Area Bell Wiring	20
(3)Manual Call Point Wiring	22
6. Annunciator Wiring	23
7. Networking Wiring	25
8. Addressable Point Number Setting	27
9. Trouble Shooting	29

QA16 System Characteristics

- Each loop can connect with 250 devices.
- Easy system programming through PC to panel.
- Event log can store up to 2030 events.
- Individual loop module test feature to save time on panel test.
- Large LCD screen (40 x 15 lines) allows more events to be displayed on the same screen.
- Location name on the LCD shows 24 letters including spaces.
- Loop devices can be set up to be temporarily isolated.
- On-board Self-test feature for simulating alarm output.
- Optional thermal printer can printout complete panel status.
- The maximum of QA16 is 32 loops, 560 sets relay output (optional) and 4000 sets co-active.
- The programming information will not disappear due to AC power fault or standby power fault.

QA16 Addressable Fire Alarm Control Panel Manual

1. LED Description and Keypad Reference

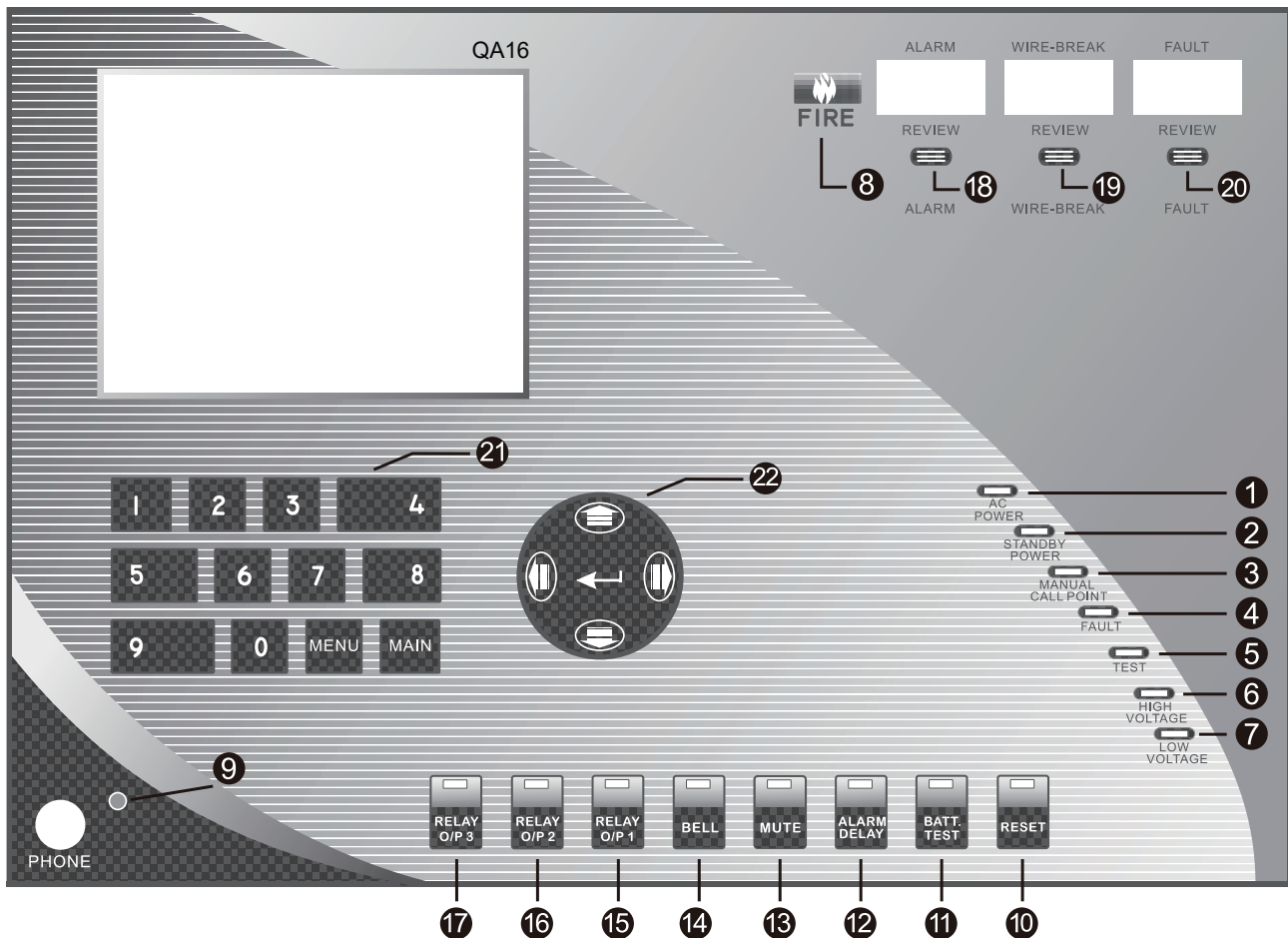

1.1. LED Description

Number	Denomination	LED Indications	Normal	Abnormal
[1]	AC POWER LED	Indicates the AC power status is under AC220V/60Hz. (Voltage Range: AC220V +/-15%)	ON	—
[2]	STANDBY POWER LED	Indicates the control panel is equipped with standby power in case of AC power failure. The standby battery will be charged when the AC power works.	—	ON
[3]	MANUAL CALL POINT LED	Immediately indicates a manual call point activation.	—	ON
[4]	FAULT LED	Indicates an active system fault condition which could include missing end-of-line resistor, loop, wirebreak, fuse, fault, module fault, AC/DC fault or repeated addressable point number. The buzzer will sound when FAULT LED goes on. Repeated addressable point number will also be indicated on the LCD.	—	ON

Number	Denomination	LED Indications	Normal	Abnormal
[5]	TEST LED	Indicates that alarm, wirebreak or disable test status.	——	ON
[6]	HIGH VOLTAGE LED	Indicates that the voltage of panel is higher than requested, eg. AC220V +15% (about 253V)	——	ON
[7]	LOW VOLTAGE LED	Indicates that the voltage of panel is lower than requested, eg. AC220V -15% (about 187V)	——	ON
[8]	FIRE LED	Indicates that the panel is receiving a fire alarm signal or is being tested. If a new fire alarm signal is received when operating this control panel, the operation will be interrupted and the fire alarm control panel will respond to the signal.	——	Blinking
[9]	PHONE LED	Indicates that a phone jack is plugged into a manual call point phone jack, the phone LED is on and the buzzer is sounding.	——	ON

1.2. Keypad Reference :

The switches are with the LEDs along the bottom of the keypad. The LEDs will be on in abnormal condition and will be off in normal condition.

[10] RESET Switch

Press RESET to reset the panel from an alarm, wirebreak and any other abnormal status. The LED is on while resetting and it goes off when the panel finishes resetting. It takes 30 seconds to reset the panel and the panel will be in normal status after checking loops for any abnormal status.

[11] BATTERY TEST Switch

Normally, a panel uses AC power. Press BATTERY TEST switch to test the backup batteries. The LED is on while testing batteries and it goes off when batteries test is finished.

[12] ALARM DELAY Switch

Alarm delay reduces false alarms due to pulse and noise signals. After ALARM DELAY is pressed, the LED is on which means alarm delay is removed. LED goes off when alarm delay is reinstated.

[13] MUTE Switch

A buzzer on the panel beeps during alarm, wirebreak and other abnormal status.

a. Temporary Mute : Press MUTE switch once to stop a buzzer temporarily. The LED will light. The buzzer will become active again if the panel detects any alarm, wirebreak and other abnormal status. Press MUTE switch again to turn off the LED.

- b. Long-Term Mute : Press MUTE switch for 3 seconds to disable the buzzer. The LED will flash. The buzzer will not be active again even if the panel detects any alarm, wirebreak and other abnormal status. Press MUTE switch again to return to normal status. The LED will go off.
- c. Fault Status : When it is in fault status, the panel buzzer beeps once every 6 seconds.
- d. Wirebreak Status : When it is in wirebreak status, the panel buzzer beeps once every 2 seconds.
- e. Alarm : When it is active, the panel buzzer beeps continuously.
- f. Monitoring Device Active : A panel buzzer beeps when the monitor device is active. It beeps 3 (short times) every 5 seconds.

[14] BELL Switch

Press BELL switch to mute bells which are connected to QA17-B control modules. The LED will light. Press BELL switch again to remove mute. The LED will go off.

[15] Relay O/P 1 Switch

Switch to stop the output device, ex. smoke evacuation system which is connected to QA17-B control module and programmed in Type 13.

[16] Relay O/P 2 Switch

Switch to stop the output device, ex. voice evacuation system.

[17] Relay O/P 3 Switch

Switch to stop the output device, ex. fire sprinkler system which is connected to QA17-B control module and programmed in Type 11.

[18~20] Review Switch

If any alarm, wirebreak, or fault happens, the LED display for ALARM, WIRE-BREAK, or FAULT will show the number of alarms. Press REVIEW switch to view the details on the LCD screen.

[21] Number Keypad, MENU Key, and MAIN Key

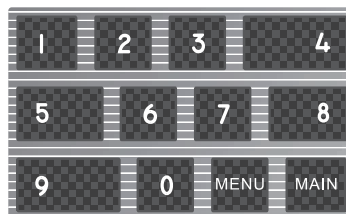

a. Number Keypad (0~9)

b. MENU Key (F) 

c. MAIN Key (ESC) 

[22] ARROW Keys, ENTER Key

a. UP, DOWN, LEFT and RIGHT

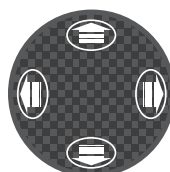

b. ENTER Key (ENT) 

2. LCD Reference

LCD screen has a protection function. If the keyboard is unused for more than 30 seconds, the LCD light goes off. Press any key to turn on the LCD light again. If the panel detects an alarm, fault or other abnormal signal, the LCD light will come on and display the details.

Users can make the following selections in the function selection list,

1. Time Setting
2. Alarm Data
3. WireBreak Data
4. Fault Data
5. History Log
6. History Log CLR
7. Alarm Delay
8. Download File
9. Output Delay
- A. Status Test
- B. Status Review
- C. Printer Setting
- D. Loop Setting
- E. System Review

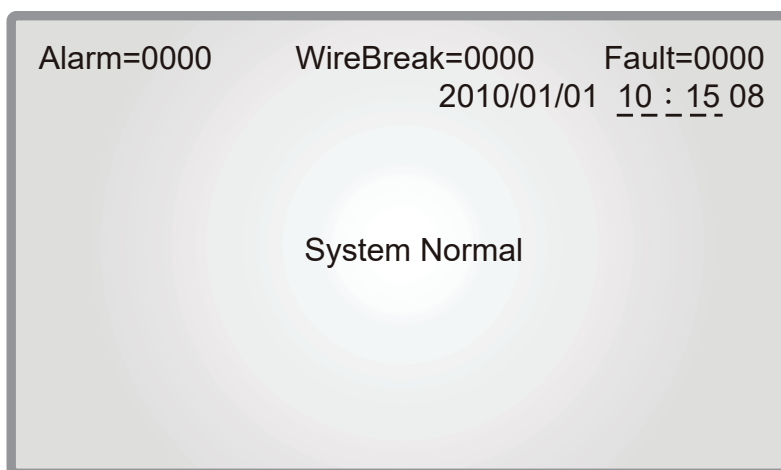

▶▶ 【Picture 1 The initial screen】

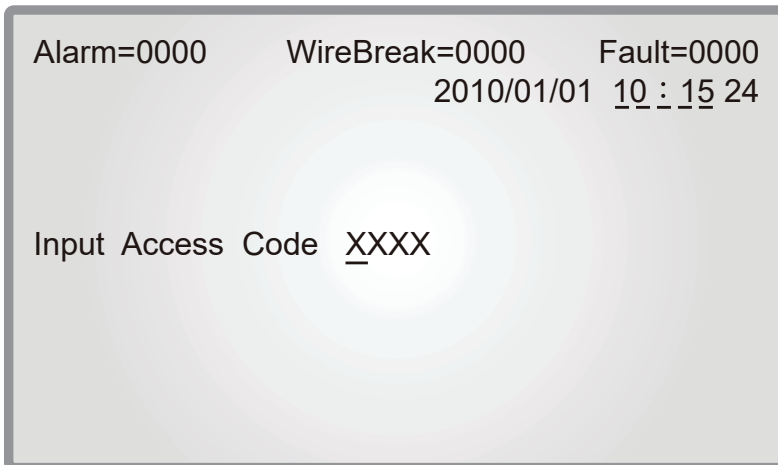

2.1. LCD Display Description

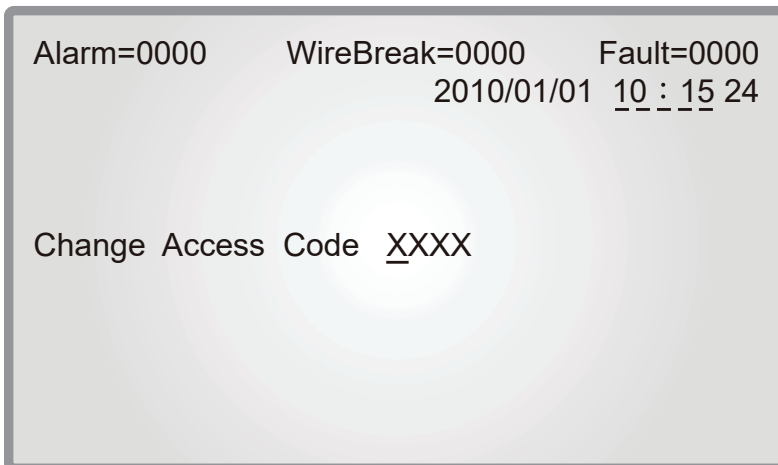

▶▶ 【Picture 2 Screen is ready for Access Code input】



▶▶ 【Picture 3 Screen is ready for Access Code change】

- (1) Before you can enter the Function Selection List Screen, you need to input the access code: "0000". The screen will return to initial screen if the code is wrong. If the access code is correct, the screen will show "Change Access code". Just please press  if you don't want to change the code. You may enter new number and press  to change the code and enter the Function Selection List Screen (The access code has been changed successfully).

※ Notice: If no items are selected, the screen will return to the initial screen after 30 seconds.

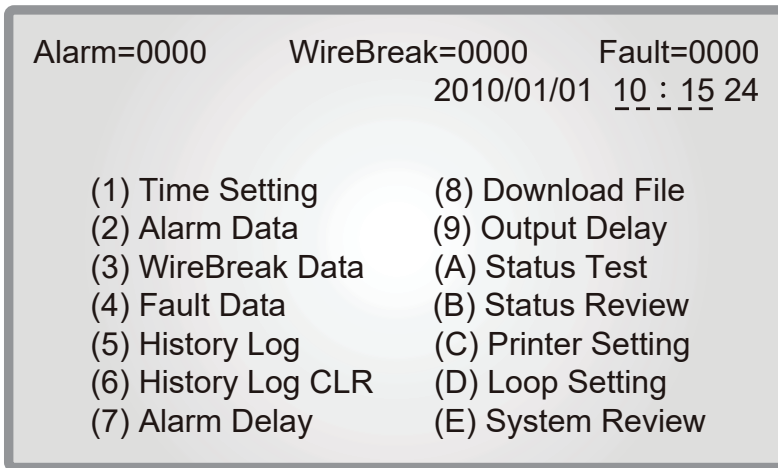

▶▶ 【Picture 4 Function Selection List Screen】

(2) Function Selection List Screen

Press **MENU**, and then press **←**. It will appear as in Picture 4.

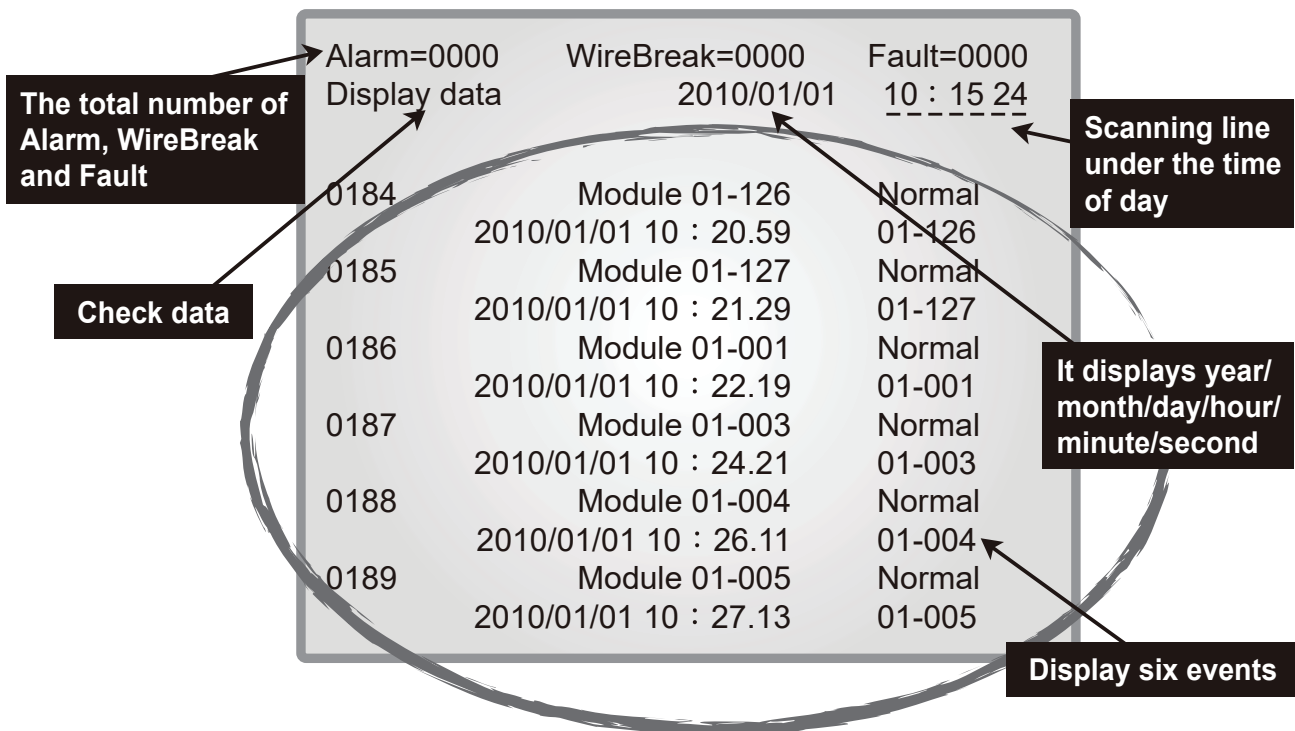



(3) The first two lines on the LCD show the system data, the date and time and the name of the function.

(4) The last 12 lines on the LCD display six events. Each event has an area name, status, activity time, kinds of module (loop number and point number).



2.2. LCD Function Selection List Instruction

(1) Time Setting

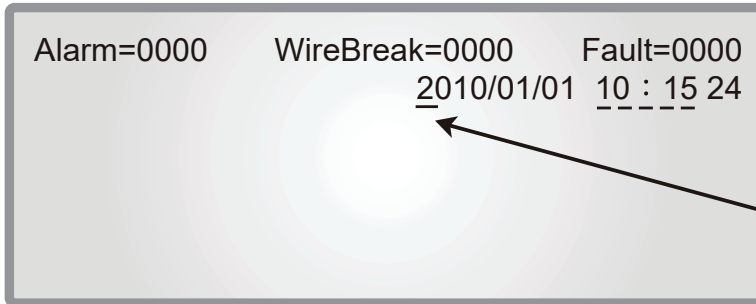

- a. Enter Function Selection List Screen first. Use  keys to choose the items. Choose (1) and then press  to enter the screen below. Press  to return to Function Selection List screen.



The cursor

- b. Use  keys to move the cursor left and right. Move to the number you want to change and press a number key. After completing, press  to change the date.

(2) Alarm Data

- a. Enter Function Selection List Screen first. Use  keys to choose the items. Choose (2) and then press  to enter the screen below. Press  to return to Function Selection List screen.

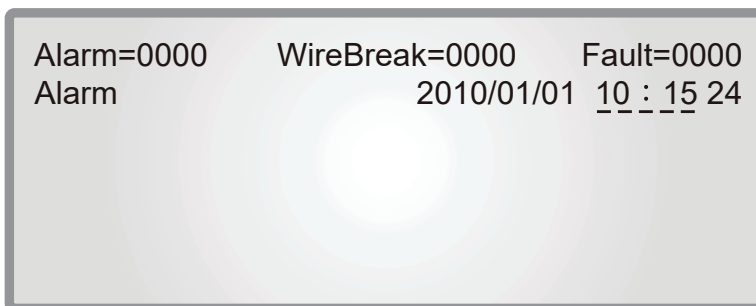

▶▶ [Picture 1 Screen shows no activity]

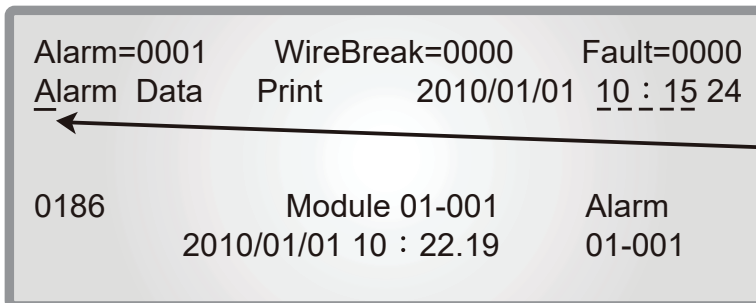



Check data or print data



▶▶ [Picture 2 Screen shows alarm activity]

- b. Picture 2 Items Description

Check : Only six events are displayed at one time. Use  keys to move up and down, so you may check all the Alarm data.

Print : Use  keys to move cursor right to “Print” and press  to print the screen. After printing, the cursor will return to Check selection. You will need check other screens before reprinting the same screen.

(3) WireBreak Data

- a. Enter Function Selection List Screen first. Use  keys to choose the items. Choose (3) and then press  to enter the screen below. Press  to return to Function Selection List screen.

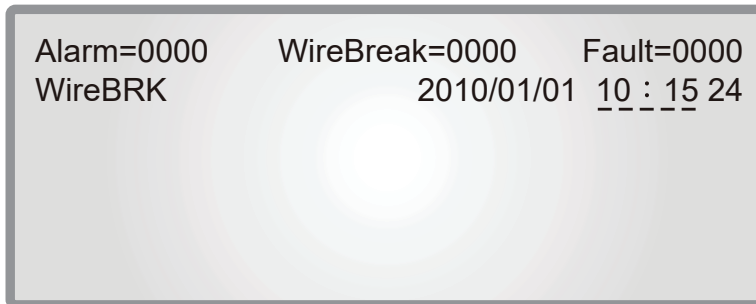

▶▶ 【Picture 1 Screen shows no activity】

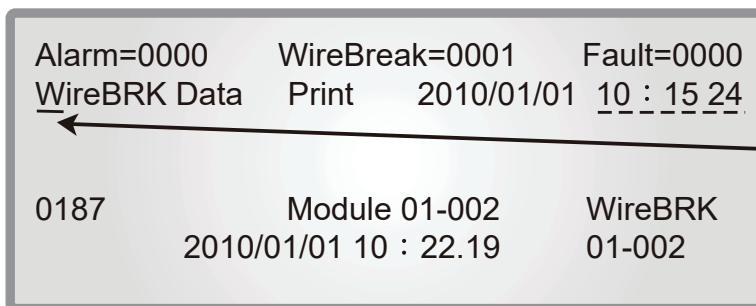



▶▶ **Check data or print data**



▶▶ 【Picture 2 Screen shows wirebreak activity】

- b. Picture 2 Items Description

Check : Use  keys to move up and down, so you may check all the WireBreak data.

Print : Use  keys to move cursor right to “Print” and press  to print the screen. After printing, the cursor will return to Check selection. You will need check other screen before reprinting the same screen.

(4) Fault Data

- a. Enter Function Selection List Screen first. Use  keys to choose the items. Choose (4) and then press  to enter the screen below. Press  to return to Function Selection List screen.

Alarm=0000	WireBreak=0000	Fault=0000
Fault	2010/01/01	10 : 15 24

▶▶ [Picture 1 Screen shows no activity]



Alarm=0000	WireBreak=0000	Fault=0001
<u>F</u> ault Data	Print	2010/01/01 10 : 15 24
0188	Module 01-003	Fault 01-003
	2010/01/01 10 : 22.19	

▶▶ Check data or print data



▶▶ [Picture 2 Screen shows fault activity]

b. Picture 2 Items Description

Check : Use  keys to move up and down, so you may check all the Fault data.

Print : Use  keys to move cursor right to "Print" and press  to print the screen. After printing, the cursor will return to Check selection. You will need check other screen before reprinting the same screen.

(5) History Log

a. Enter Function Selection List Screen first. Use  keys to choose the items. Choose (5) and then press  to enter the screen below. Press  to return to Function Selection List screen.

※ History Log can save 2030 events.



Alarm=0000	WireBreak=0000	Fault=0000
<u>H</u> istory Log	Print	2010/01/01 10 : 15 24
0184	Module 01-126	Normal 01-126
	2010/01/01 10 : 20.59	
0185	Module 01-127	Normal 01-127
	2010/01/01 10 : 21.29	
0186	Module 01-001	Normal 01-001
	2010/01/01 10 : 22.19	
0187	Module 01-003	Normal 01-003
	2010/01/01 10 : 24.21	
0188	Module 01-004	Normal 01-004
	2010/01/01 10 : 26.11	
0189	Module 01-005	Normal 01-005
	2010/01/01 10 : 27.13	

▶▶ Check data or print data



▶▶ [Picture 2 Screen shows History Log activity]

b. Picture 2 Items Description



Check : Use  keys to move up and down, so you may check all the History Log.

Print : Use  keys to move cursor right to "Print" and press  to print the screen. After printing, the cursor will return to Check selection. You will need check other screen before reprinting the same screen.

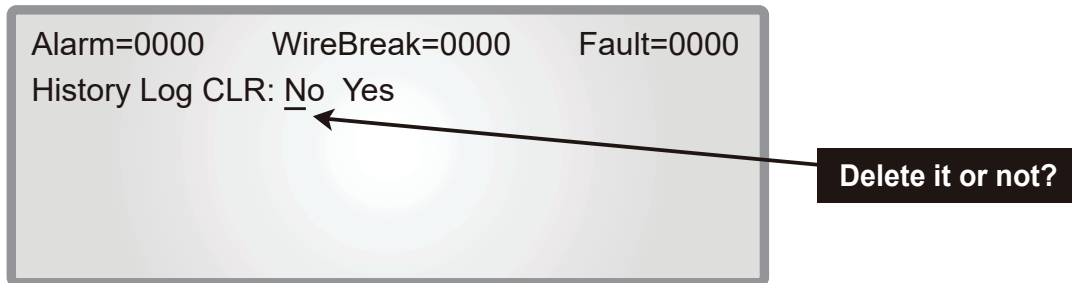

(6) History Log CLR

- a. To clear the memory: Enter Function Selection List Screen first. Use  keys to choose the items. Choose (6) and then press  to enter the screen below. Press  to return to Function Selection List screen.



- b. After entering above screen, choose whether to delete the memory data or not. Use  keys to move right and left. To delete all the data, choose YES and then press . It will be return to checking memory data screen after deleting data.

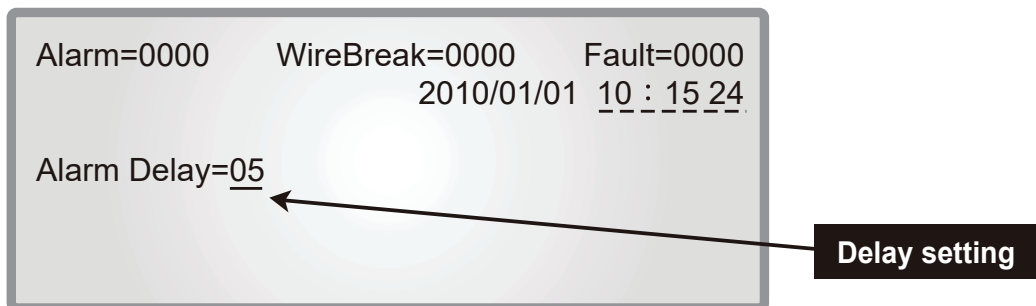

(7) Alarm Delay

- a. Enter Function Selection List Screen first. Use  keys to choose the items. Choose (7) and then press  to enter the screen below. Press  to return to Function Selection List screen.





- b. This screen sets the length of the time the alarm delays before responding to incoming signals. Press  to move up and down to increase or decrease the value. The number options are 05 seconds, 10 seconds, 15 seconds, 20 seconds, 25 seconds, 30 seconds, 35 seconds or 40 seconds.

(8) Download File

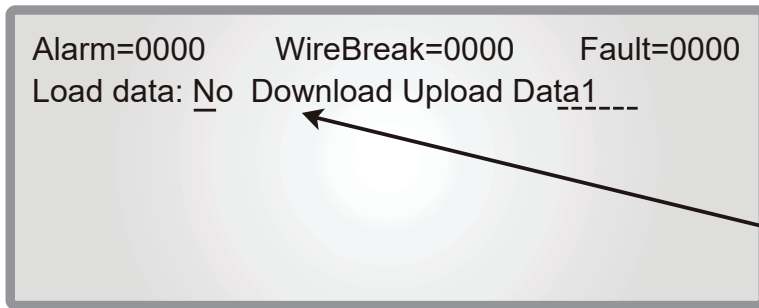
- a. Enter Function Selection List Screen first. Use  keys to choose the items. Choose (8) and then press  to enter the screen below. Press  to return to Function Selection List screen.





Download, Upload or not

b. USE  keys to move the cursor left or right to answer Download, Upload or No, and move up and down to select the Data Bank Number. Press  to download, upload or exit.

※ Notice for download and upload: Please refer to our programming manual.

(9) Output Delay

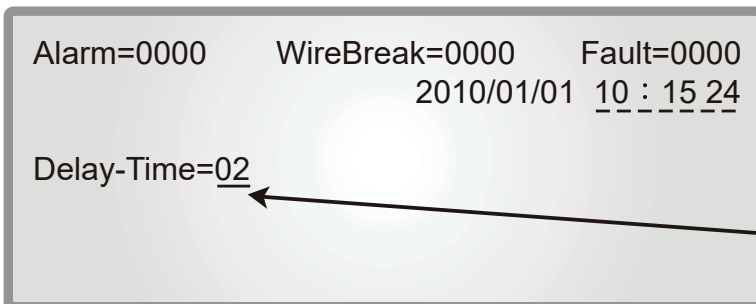

a. Enter Function Selection List Screen first. Use  keys to choose the items. Choose (9) and then press  to enter the screen below. Press  to return to Function Selection List screen.



Delay-Time Setting

b. This screen sets the length of the time the control panel delays before activating external modules, such as sounders. Press  keys to increase or decrease the value. The numbers set the time delay, 01=1 second, 02=2 seconds, 03=3 seconds, then up to 99 (99 seconds).

(A) Status Test

a. Enter Function Selection List Screen first. Use  keys to choose the items. Choose (A) and then press  to enter the screen below. Press  to return to Function Selection List screen.

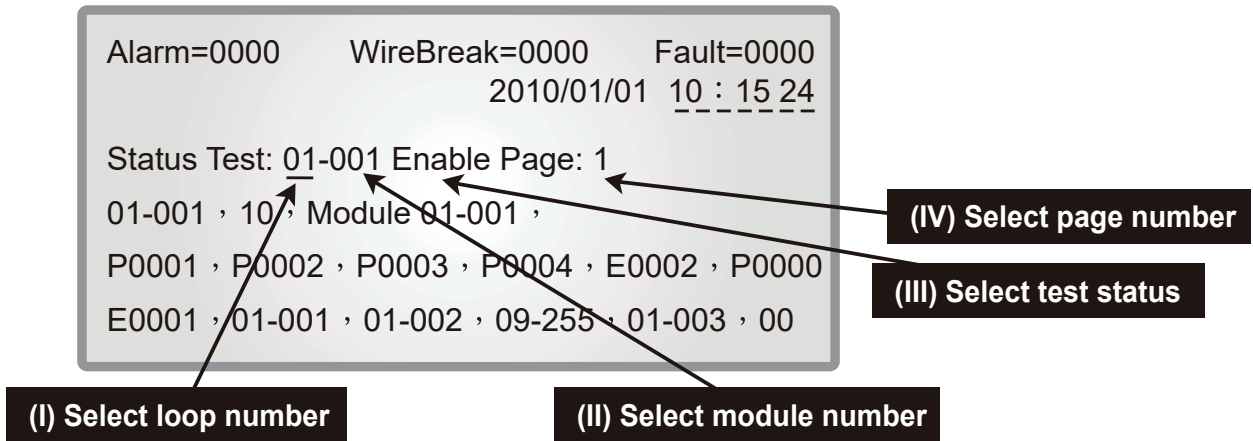

b. Selection Description

- (I) Select loop number : Press up and down keys to find the loop number you want to test (01~08).
- (II) Select module number : To select the module number, press keys to move the cursor to the right, then use up and down keys to find the module number you want to test (001~250).
- (III) Select test status : To select the test status, press keys to move the cursor to the right, then use up and down keys to find the test status you want to test: Enable, Alarm, WireBreak or Disable.
 After choosing loop number, module number and test status, press key to conduct the test. Choose Enable status and press to return to the previous test status.
- (IV) Select page number: To select the page number, press keys to move the cursor to the right, then use up and down keys to find the page number you want to check. (page 1~4)
 ※ You may also check the simultaneous action and relay output function, and confirm the programming.

(B) Status Review

- a. Enter Function Selection List Screen first. Use keys to choose the items. Choose (B) and then press to enter the screen below. Press to return to Function Selection List screen.

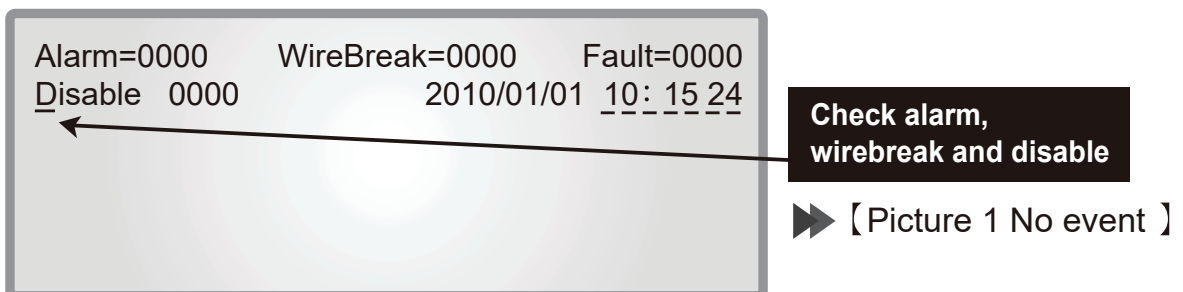



Alarm=0007	WireBreak=0000	Fault=0000
Alarm	0007_Page2	2010/01/01 10 : 15 24
0001	NO1 Module	01-001
0002	NO2 Module	01-002
0003	NO3 Module	01-003
0004	NO4 Module	01-004
0005	NO5 Module	01-005
0006	NO6 Module	01-006



Indicates more than 6 events

▶▶ [Picture 2 More than 6 events]

b. Picture 1: To check all the test states, use  keys to move from one test status to another.



Picture 2: It shows "Page" when there are more than 6 events. To check all events, press  keys to move the cursor to the right, then use up and down  keys to check all the events.

(C) Printer Setting

a. Enter Function Selection List Screen first. Use  keys to choose the items. Choose (C) and then press  to enter the screen below. Press  to return to Function Selection List screen.

Alarm=0000	WireBreak=0000	Fault=0000
Printer <u>Disable</u>	2010/01/01	10 : 15 24



Choose enable or disable

b. Use  keys to move up and down to choose enable or disable, and then press .





Enable: It prints automatically when receiving any signal of alarm, wirebreak, AC power or battery power shortage and restoration, or other abnormal signal.

Disable: You need to select print and press  to print the signals of alarm, wirebreak, AC power or battery power shortage and restoration, or other abnormal signal.

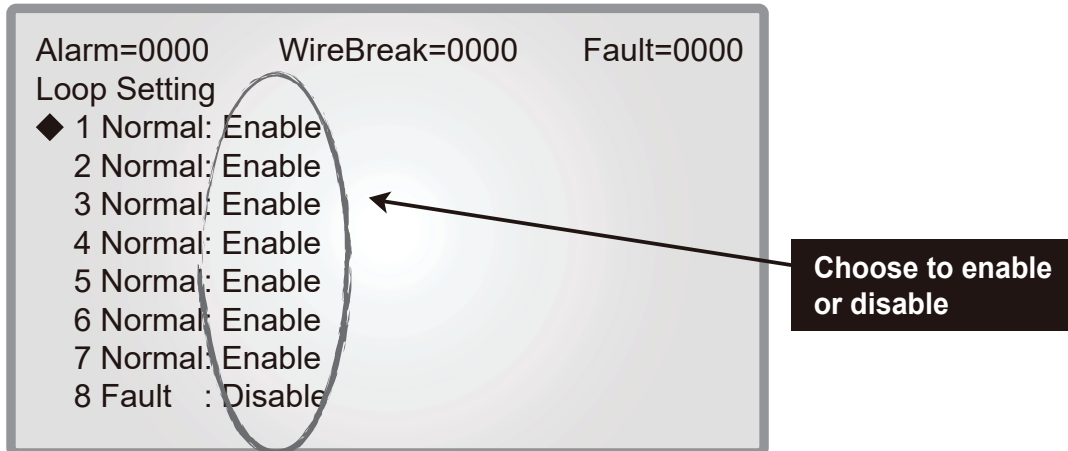

(D) Loop Setting

- a. Enter Function Selection List Screen first. Use  keys to choose the items. Choose (D) and then press  to enter the screen below. Press  to return to Function Selection List screen.



- b. Use  keys to move up and down to choose the loop number. (from loop 1 to loop 8) After choosing the loop, use  keys to move left and right to enable or disable and then press . After pressing , the panel will reset and enable or disable the chosen loop.
- ※ Next to the loop number, you may see Normal which means this loop is connected to a PC board. If it shows Fault, it means the PC board is disconnected. Whenever the panel is turned on, it checks all the loops. For example, if the PC boards of loop 1, 2, 3, 4, 6, 8 are connected, the LCD displays loop 1, 2, 3, 4, 6, 8 Normal and loop 5 and 7 Fault.

(E) System Review

- a. Enter Function Selection List Screen first. Use  keys to choose the items. Choose (E) and then press  to enter the screen below. Press  to return to Function Selection List screen.

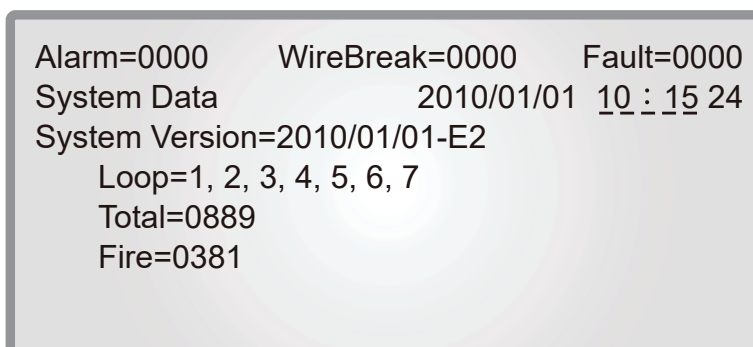

- b. Here you may check system data, for example number of loops (the enabled loops), total number of modules (250), and fire events.

3. System Wiring Instruction

- (1) Signal wire: 2-core 1.2mm shielded wire X 1(S+, S-)
 - ※ Distance less than 500m, use 1.2mm wire. Distance from 500m to 1000m, use 2.0mm
 - ※ Signal wire is used with EMT to avoid being affected by other power sources, especially those over 110 or 220 V AC
 - ※ Use heatproof (HR) wiring to connect panel to modules
 - ※ Wire usage should be in accordance with the local regulation
- (2) Indicating-lamp wire: 1.6mm X 2
- (3) Telephone wire: 1.6mm X 2 (TL, Tc)
- (4) Bell wire: SND 1.6mm X 2 for bell and buzzer
- (5) Load power wire: 1.6mm X 2

4. Installation and Testing Notes

- (1) The wire to detectors should not be too close to the installation screw in the detector to avoid false alarms and low resistance.
- (2) The resistance DC 500V between conventional detector contacts L and LC and ground must be at least 1MΩ.
- (3) The resistance DC 500V between this addressable control panel contacts S+,S- and ground must be at least 2MΩ.
- (4) Use wires of different color to avoid confusion.
- (5) Keep distance between wires and label wires clearly.
- (6) The total maximum power output is 24V DC 2 A for bell, indicating-lamp and load. Use additional power supply if more than the maximum power output is required.
 - ※ Please add terminal blocks on each floor to check wire.
- (7) Fuses:

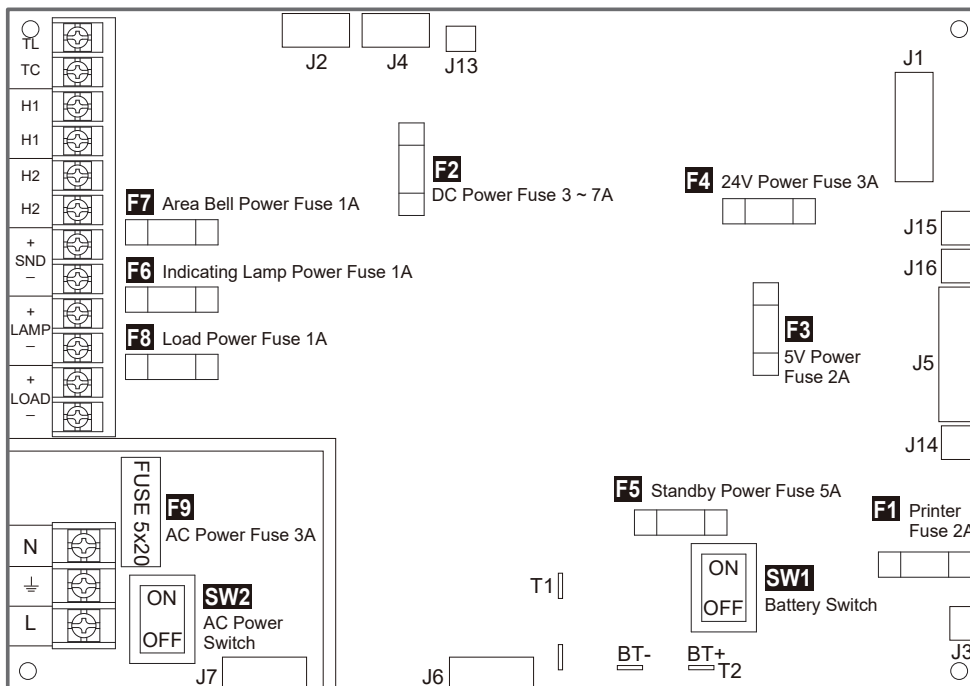

5. Wiring Diagram

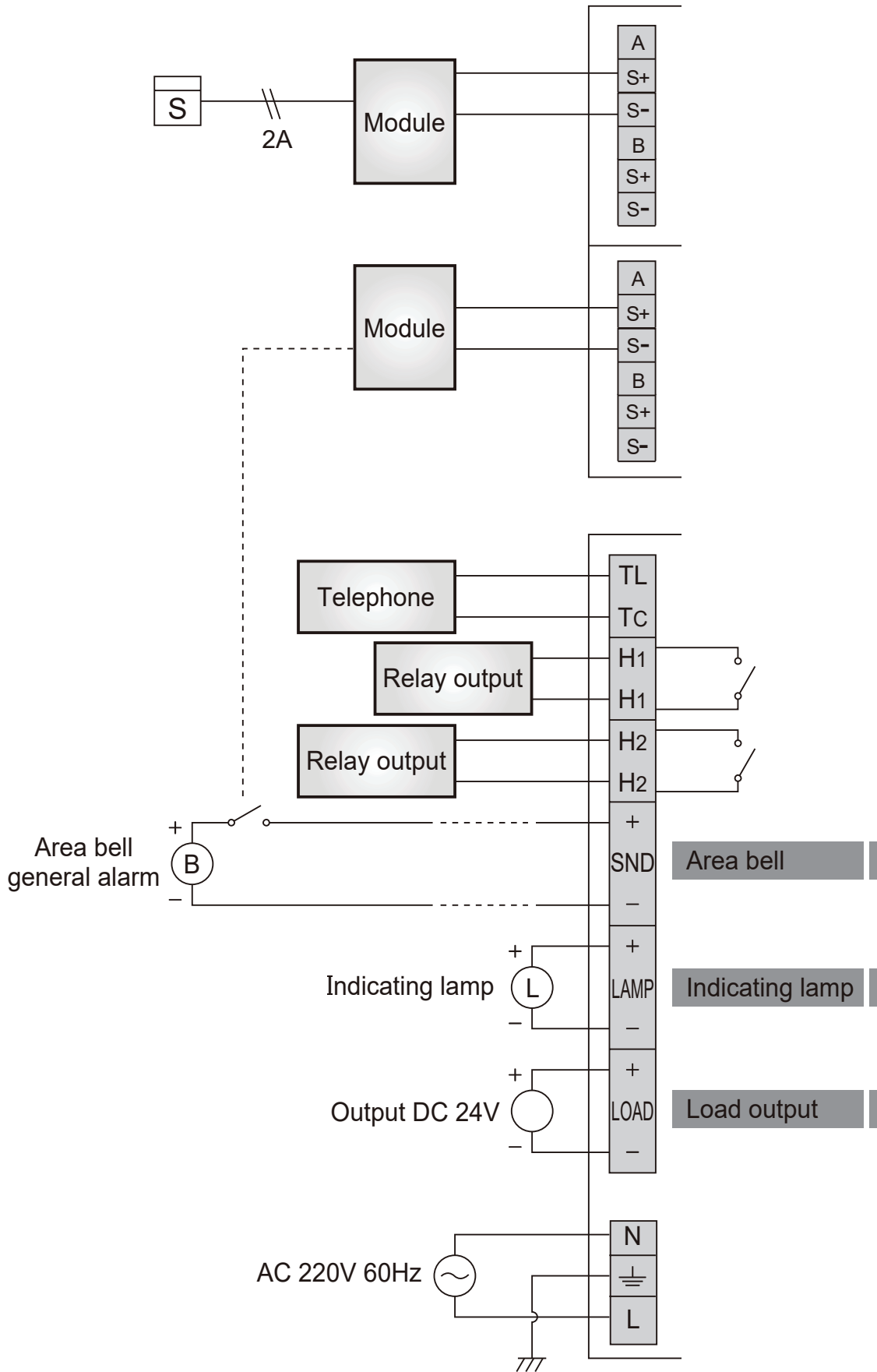

(1) Detector Wiring

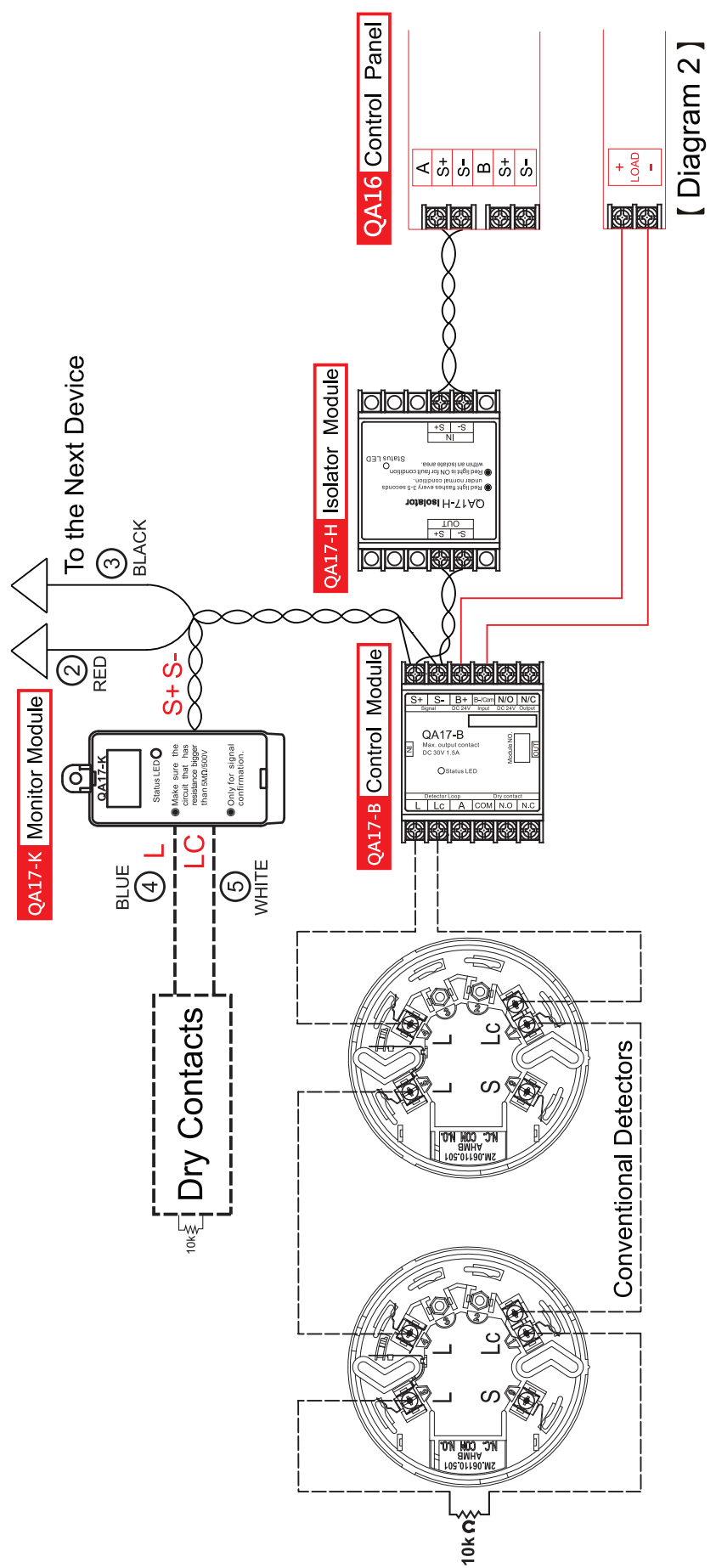
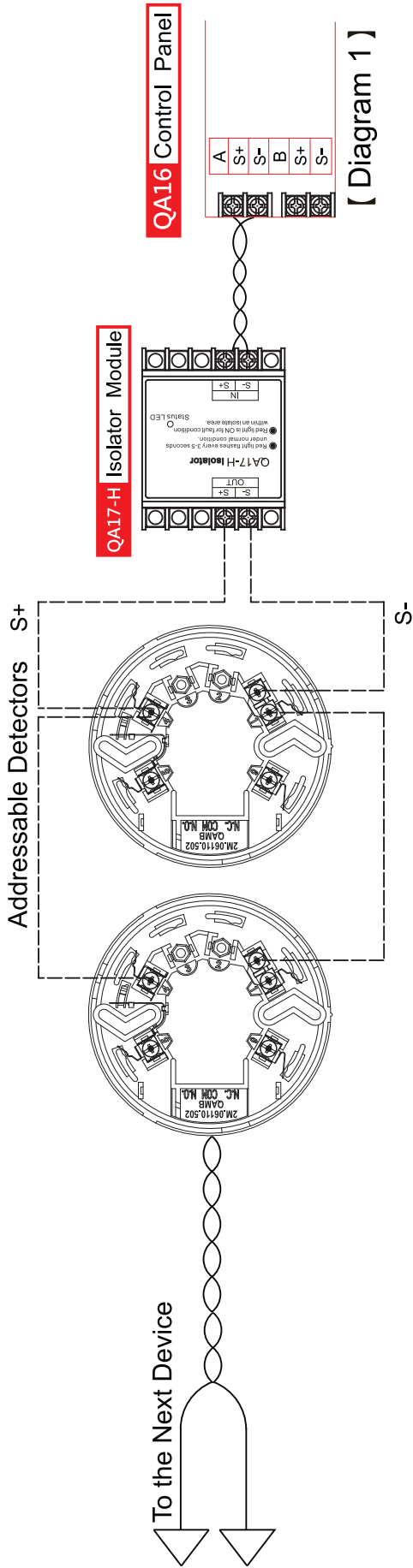

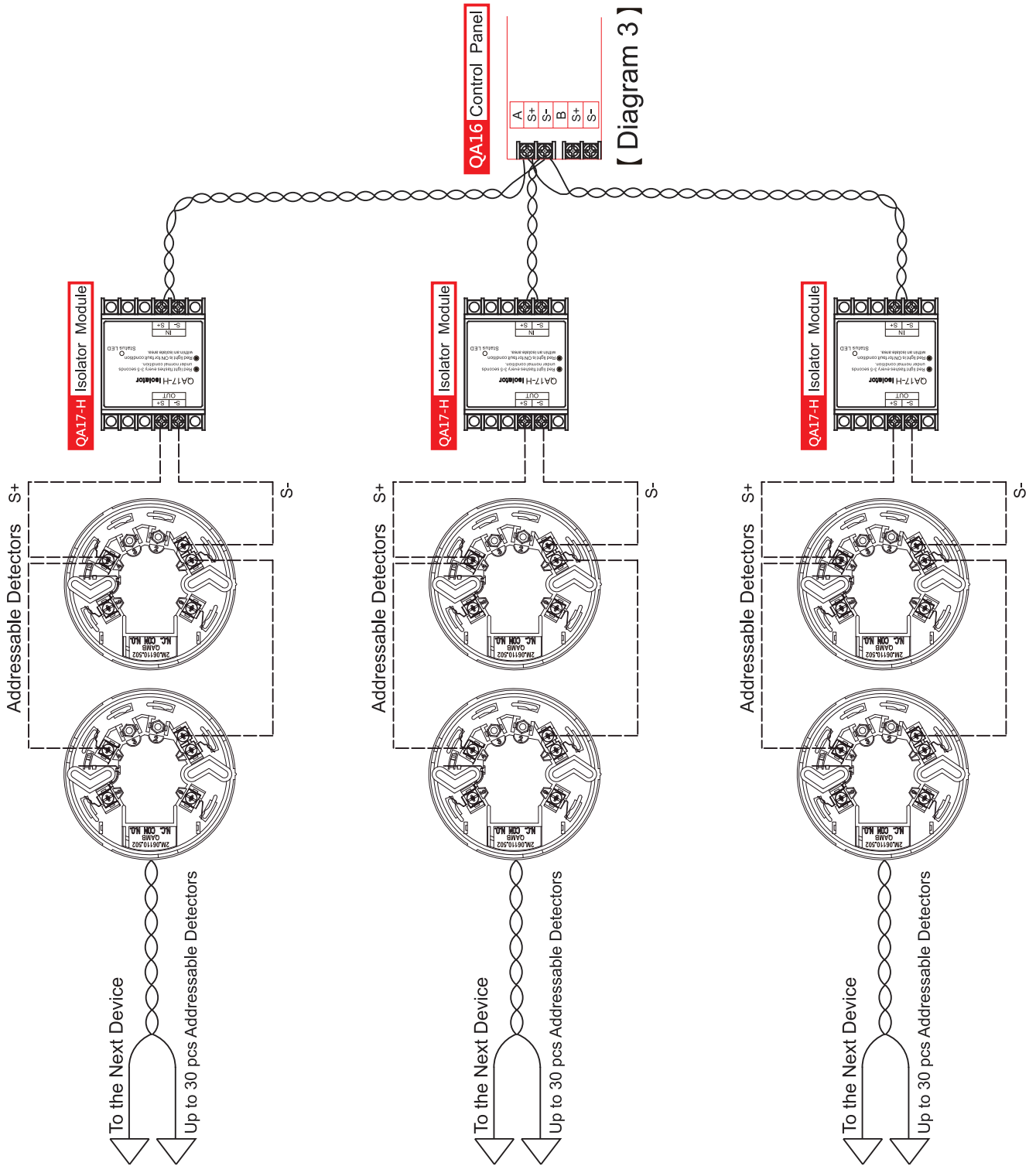

(2) Area Bell Wiring

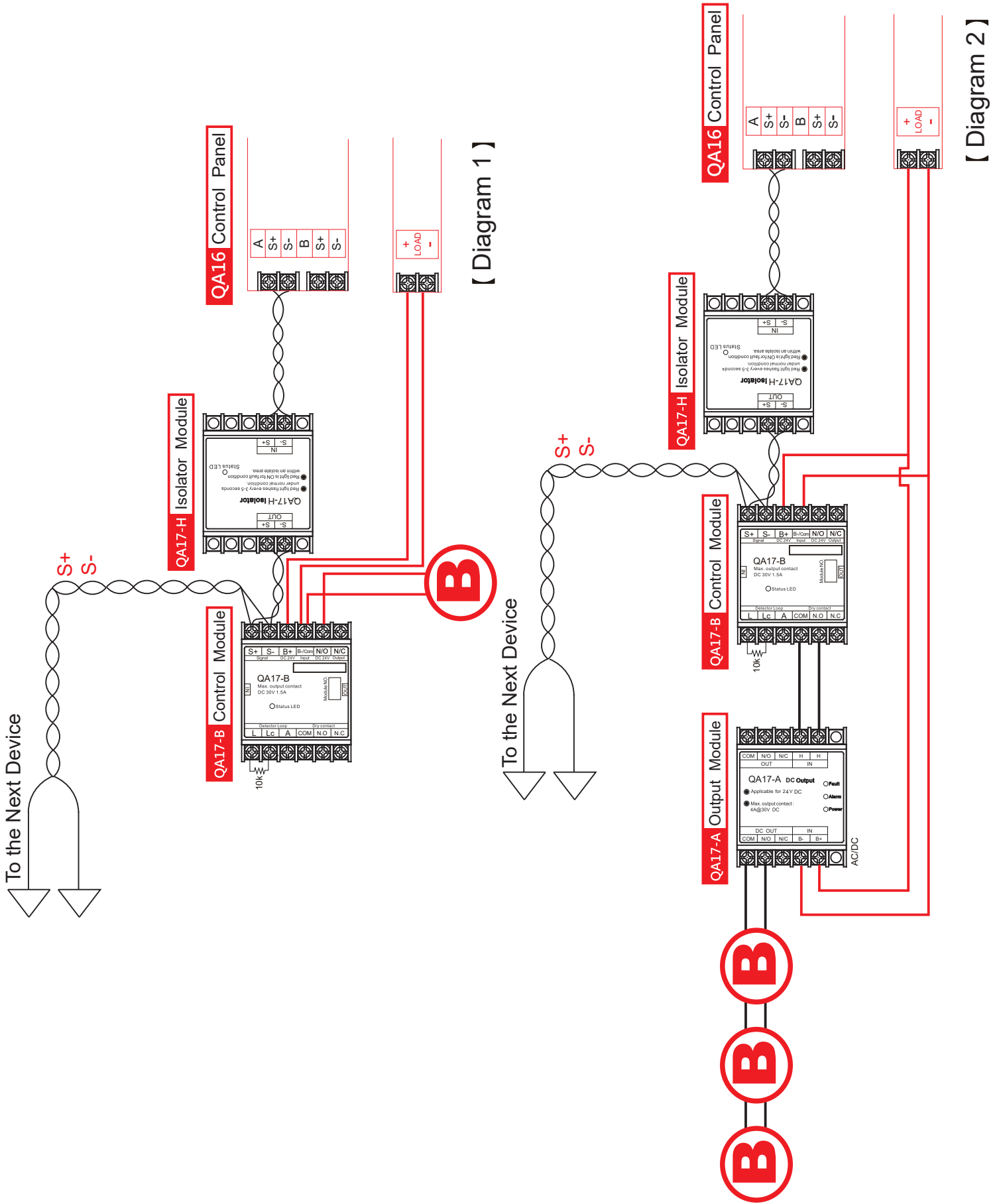

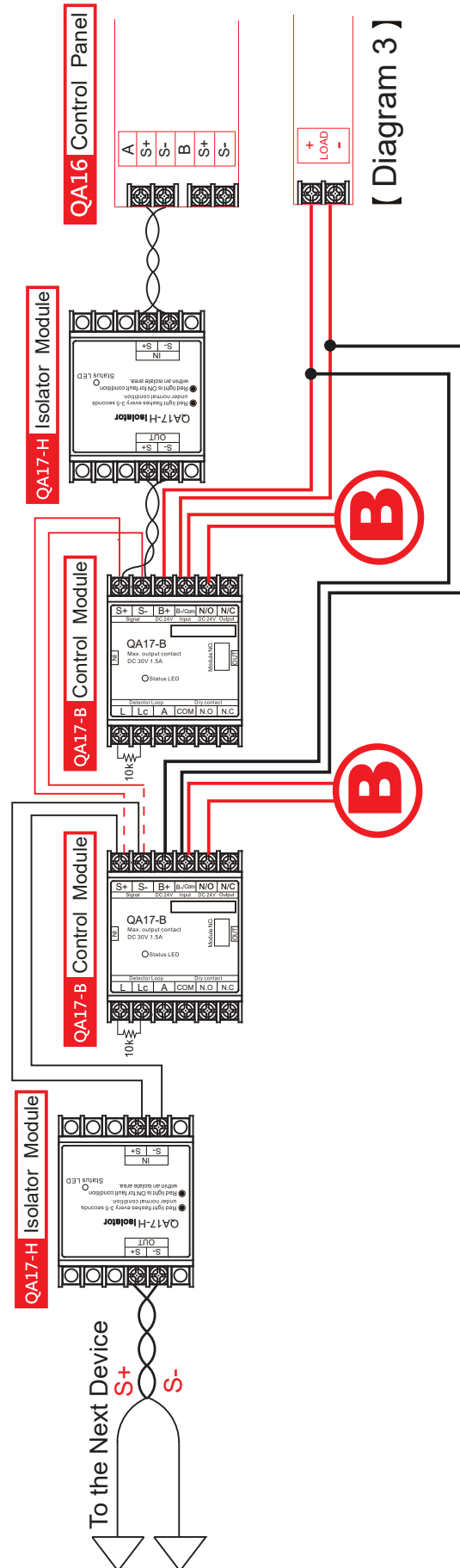

【 Diagram 3 】

To the Next Device
 S+
 S-

(3) Manual Call Point Wiring

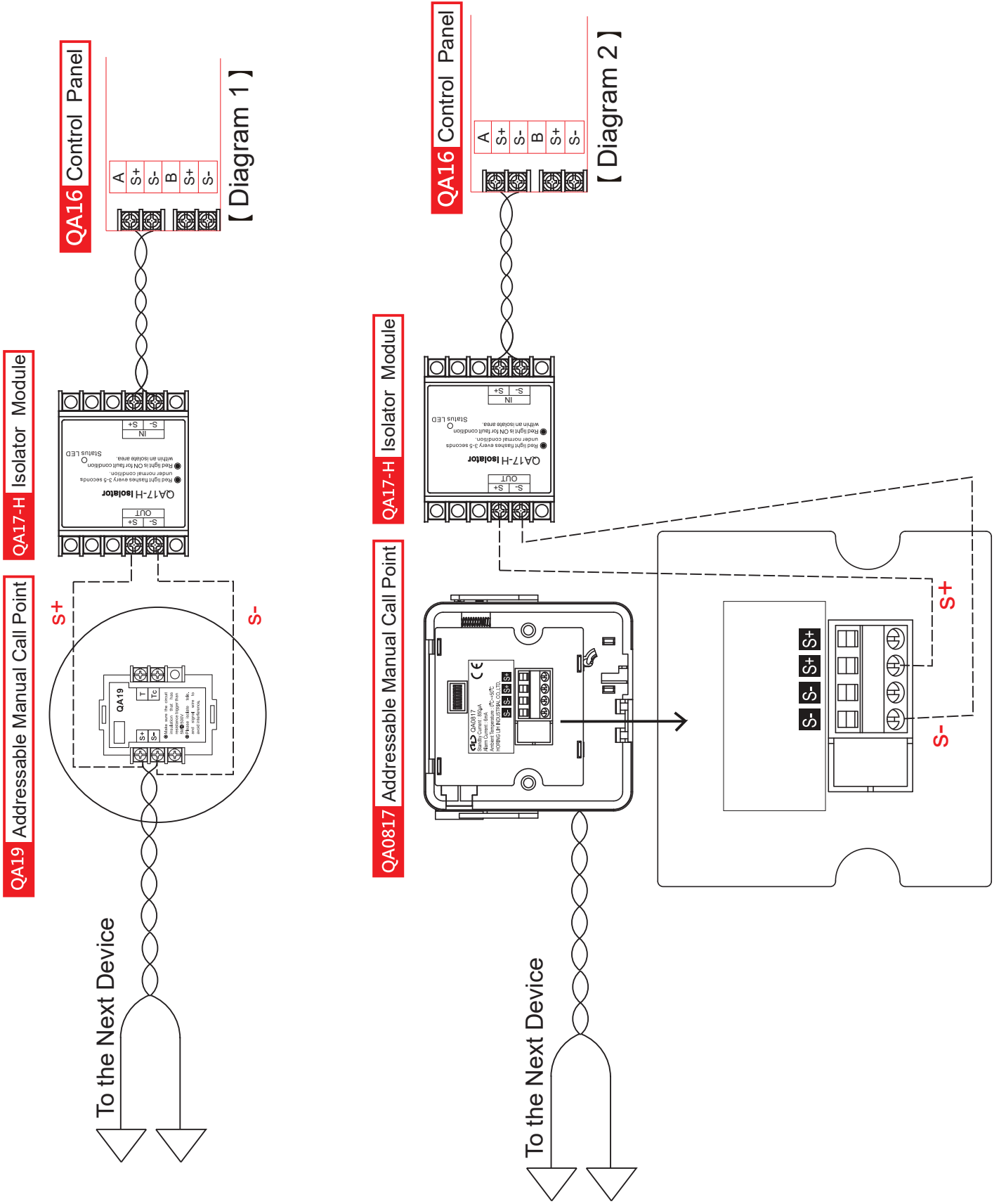

6. Annunciator Wiring

(1) Signal contacts:

Connect QA16 control panel's "S+" to annunciator's "S"
Connect QA16 control panel's "S-" to annunciator's "SC"



QA16 control panel's
S+ & S- contacts

(2) Telephone contacts:

Connect QA16 control panel's "TL" to annunciator's "T"
Connect QA16 control panel's "TC" to annunciator's "TC"

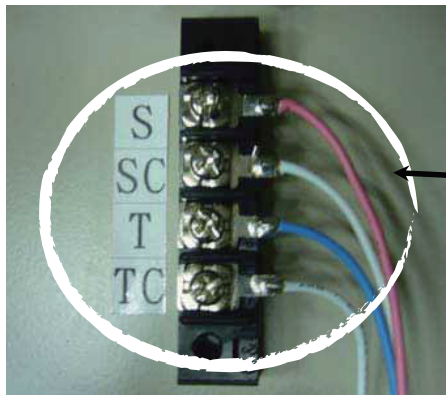

QA16 annunciator's
S, SC, T and TC
contacts

(3) DIP switch settings

a.(I) QA16 control panels without annunciators: Please adjust the switch to "0" for the control panels.

(II) QA16 control panels with annunciators: Please adjust the switch to "1" for all control panels and "2" for all annunciators.



Rotary Dip Switch on
PCB No. 05316-2D

- b. All control panels and annunciators need binary dip switch number, so please set up the dip switch in the control panel and annunciators from No. 1 to No. 32.

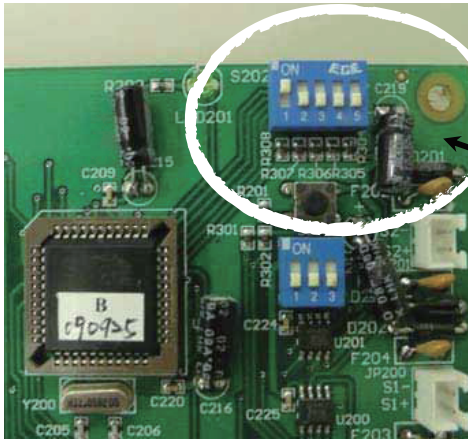

Binary Dip Switch on PCB No. 05316-2D



Example: Panel No. 1

“ ON ” position is “ 1 ” and numeric is “ 0 ”. For example, the first control panel is 10000, the second panel is 01000 and so on. Control panel number’s corresponding dip switch is as below.

Panel No.	DIP switch	Panel No.	DIP switch	Panel No.	DIP switch	Panel No.	DIP switch
01	10000	09	10010	17	10001	25	10011
02	01000	10	01010	18	01001	26	01011
03	11000	11	11010	19	11001	27	11011
04	00100	12	00110	20	00101	28	00111
05	10100	13	10110	21	10101	29	10111
06	01100	14	01110	22	01101	30	01111
07	11100	15	11110	23	11101	31	11111
08	00010	16	00001	24	00011	32	*

7. Networking Wiring

- (1) All control panels need binary dip switch number, so please set up the dip switch in the control panel and another control panel from No. 1 to No. 32.

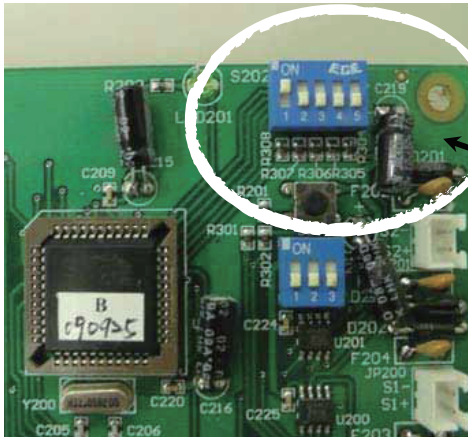

**Binary Dip Switch on
PCB No. 05316-2D**



Example: Panel No. 1

“ ON ” position is “ 1 ” and numeric is “ 0 ”. For example, the first control panel is 10000, the second panel is 01000 and so on. Control panel number's corresponding dip switch is as below.

Panel No.	DIP switch	Panel No.	DIP switch	Panel No.	DIP switch	Panel No.	DIP switch
01	10000	09	10010	17	10001	25	10011
02	01000	10	01010	18	01001	26	01011
03	11000	11	11010	19	11001	27	11011
04	00100	12	00110	20	00101	28	00111
05	10100	13	10110	21	10101	29	10111
06	01100	14	01110	22	01101	30	01111
07	11100	15	11110	23	11101	31	11111
08	00010	16	00001	24	00011	32	*

- (2) DIP switch settings

QA16 control panels : Please adjust the switch to “2”.



**Rotary Dip Switch on
PCB No. 05316-2D**

(3) Signal contacts:

Connect QA16 control panel's "S+" to another control panel's "S"

Connect QA16 control panel's "S-" to another control panel's "SC"



QA16 control panel's
S+ & S- contacts

8. Addressable Point Number Setting

Please set up the binary dip switch of modules(QA17-B, QA17- K), addressable detectors (QA01, QA05, QA06) and manual call points(QA19, QA0817) from No. 1 to No. 250.



Example: Device No. 1

“ ON ” position is “1 ” and numeric is “ 0 ”. For example, the first device number is 10000000, the second device is 01000000 and so on. Device number’s corresponding dip switch is as below.

Device No.	Dip Switch	Device No.	Dip Switch	Device No.	Dip Switch	Device No.	Dip Switch	Device No.	Dip Switch
01	10000000	51	11001100	101	10100110	151	11101001	201	10010011
02	01000000	52	00101100	102	01100110	152	00011001	202	01010011
03	11000000	53	10101100	103	11100110	153	10011001	203	11010011
04	00100000	54	01101100	104	00010110	154	01011001	204	00110011
05	10100000	55	11101100	105	10010110	155	11011001	205	10110011
06	01100000	56	00011100	106	01010110	156	00111001	206	01110011
07	11100000	57	10011100	107	11010110	157	10111001	207	11110011
08	00010000	58	01011100	108	00110110	158	01111001	208	00001011
09	10010000	59	11011100	109	10110110	159	11111001	209	10001011
10	01010000	60	00111100	110	01110110	160	00000101	210	01001011
11	11010000	61	10111100	111	11110110	161	10000101	211	11001011
12	00110000	62	01111100	112	00001110	162	01000101	212	00101011
13	10110000	63	11111100	113	10001110	163	11000101	213	10101011
14	01110000	64	00000010	114	01001110	164	00100101	214	01101011
15	11110000	65	10000010	115	11001110	165	10100101	215	11101011
16	00001000	66	01000010	116	00101110	166	01100101	216	00011011
17	10001000	67	11000010	117	10101110	167	11100101	217	10011011
18	01001000	68	00100010	118	01101110	168	00010101	218	01011011
19	11001000	69	10100010	119	11101110	169	10010101	219	11011011
20	00101000	70	01100010	120	00011110	170	01010101	220	00111011
21	10101000	71	11100010	121	10011110	171	11010101	221	10111011
22	01101000	72	00010010	122	01011110	172	00110101	222	01111011
23	11101000	73	10010010	123	11011110	173	10110101	223	11111011
24	00011000	74	01010010	124	00111110	174	01110101	224	00000111
25	10011000	75	11010010	125	10111110	175	11110101	225	10000111
26	01011000	76	00110010	126	01111110	176	00001101	226	01000111
27	11011000	77	10110010	127	11111110	177	10001101	227	11000111
28	00111000	78	01110010	128	00000001	178	01001101	228	00100111
29	10111000	79	11110010	129	10000001	179	11001101	229	10100111
30	01111000	80	00001010	130	01000001	180	00101101	230	01100111

Device No.	Dip Switch	Device No.	Dip Switch	Device No.	Dip Switch	Device No.	Dip Switch	Device No.	Dip Switch
31	11111000	81	10001010	131	11000001	181	10101101	231	11100111
32	00000100	82	01001010	132	00100001	182	01101101	232	00010111
33	10000100	83	11001010	133	10100001	183	11101101	233	10010111
34	01000100	84	00101010	134	01100001	184	00011101	234	01010111
35	11000100	85	10101010	135	11100001	185	10011101	235	11010111
36	00100100	86	01101010	136	00010001	186	01011101	236	00110111
37	10100100	87	11101010	137	10010001	187	11011101	237	10110111
38	01100100	88	00011010	138	01010001	188	00111101	238	01110111
39	11100100	89	10011010	139	11010001	189	10111101	239	11110111
40	00010100	90	01011010	140	00110001	190	01111101	240	00001111
41	10010100	91	11011010	141	10110001	191	11111101	241	10001111
42	01010100	92	00111010	142	01110001	192	00000011	242	01001111
43	11010100	93	10111010	143	11110001	193	10000011	243	11001111
44	00110100	94	01111010	144	00001001	194	01000011	244	00101111
45	10110100	95	11111010	145	10001001	195	11000011	245	10101111
46	01110100	96	00000110	146	01001001	196	00100011	246	01101111
47	11110100	97	10000110	147	11001001	197	10100011	247	11101111
48	00001100	98	01000110	148	00101001	198	01100011	248	00011111
49	10001100	99	11000110	149	10101001	199	11100011	249	10011111
50	01001100	100	00100110	150	01101001	200	00010011	250	01011111

9. Trouble Shooting



QA16 Basic Problem Shooting Q&A

Q1. Panel turned on abnormally, all lights of control board are ON?

- A: 1. U1 of PCB 05316-2D is not installed well or it has program fault.
2. Dipswitch S1 of PCB 05316-2D not all been pushed down to OFF.

Q2. Panel turned on abnormally, LCD screen only shows 'Loop Test 0 01 01'?

- A: First to replace the PCB 05316-2D or loop module with new one, to find out if the problem is caused by either one of them.

Q3. Loop module is not operated or faulty? Screen shows Loop # Fault?

- A: 1. Check the rotary switch if it's setting is correct.
2. Verify the program data on Loop Setting.
3. Verify loop module LED D28 (D29), D30 (D33), D31 (D34) if they are flash, if not please check the power of J5 (J6).
4. Go to LCD Function Selection List on '(D) Loop Setting', check if it is set to Enable, if shows fault or Disable please verify the program data on Loop Setting.

Q4. All address shows fault, but no loop fault?

- A: 1. Check the loop module LED (D30,D33) if they are light steady, if yes that means external over load or loop module has faulty component.
2. Check loop module fuse F3, F4(2A).
3. Check S+, S- for wire loosen.
4. Measure S+,S- for output voltage and LED D28(D29), the normal output voltage should be around 26.5V, neither 21~24V or 31V are normal.

Q5. Panel and annunciator would not communicate well?

- A: 1. Check the IP setting dipswitch (S202) of PCB 05316-2D if it is correct panel IP number.
2. Check the rotary switch SW27 of PCB 05316-2D if it is on 1 or 2.
3. Check the program data if the multiple IP setting is correct.
4. Check the JP200 of 05316-2D and S+,S- for wire connection.
5. Check the corrected polarity on S+ and S- between all connected panels.
6. Replace PCB 05316-2D.

Q6. Panel LED display screen does not show anything or show messy code?

- A: 1. Check the JP9 of PCB 05316-2D and J1/J2 of LED display if they are connected correctly, as well as the cable wire.
2. Check the IC (U1) of PCB 05316-2D and LED display if they are installed well.
3. Replace LED display or PCB 05316-2D to find out which one cause trouble.

- Q7. Panel LCD is not working?
A: 1. Check the wire connection between DS1 of 05316-2D and LCD.
2. Adjust VR1 of 05316-2D.
3. Replace LCD.
- Q8. When panel has no reaction during operation, how to tell panel is still running or breakdown?
A: Up right corner of LCD has a dotted line under real time, the line will increased from 1 to 7 and repeat cyclic, if the line stop cycling or disappear it means panel is breakdown. When panel has many events in process, the operation of panel board becomes difficult due to the system is busy.
- Q9. AC Power LED is not ON?
A: 1. Check the input power source and wire connection.
2. Check the AC power fuse (F9), Red LED (D26) will ON if the fuse is burnt.
- Q10. Standby power is not working?
A: 1. Check the battery wire connection or Standby power switch (SW1).
2. Check the standby power fuse (F5), Red LED (D24) will be ON if the fuse is burnt.
3. Switch off AC power and make sure the battery terminal has 24V or higher.
- Q11. Panel control board has Fault LED ON?
A: Review the trouble data showed on LCD then process proper shooting.
- Q12. Printer does not work?
A: 1. Check printer if the paper is available.
2. Check the printer power.
3. Go to the Function Selection List on '(C) Printer Setting', check if it is set to enable.
- Q13. Phone communication does not work?
A: 1. Check the phone wire connection.
2. Try a new phone.
- Q14. Panel shows module is disconnected, and module's disconnection LED is ON?
A: 1. Check the wiring for connected detector.
2. Check the EOL resistor if it is well connected.
3. Replace a new module.

- Q15. Conventional detector is active but panel does not receive signal?
A: 1. Check the wire connection between module and panel.
2. Check the alarm LED on module if it is ON.
3. Replace a new module.
4. Check detector's alarm current if it is too high.
- Q16. FIRE LED does not light ON?
A: 1. Check the LED if it is burnt.
2. Check all connected wiring for loosen.
3. Check the F3 fuse if it is burnt (fault LED D5 will ON).
- Q17. Alarm bell does not sound?
A: 1. Check the bell switch on panel if it is OFF.
2. Check the alarm bell if it is disconnected or fault.
3. Check bell terminal of module if it is active.
- Q18. Panel buzzer does not sound?
A: 1. Check module dry contact if it is active, if not please check the module.
2. Check the buzzer if it is faulty or no power.
3. Check the panel's B+ fuse if it is burnt.
4. Check the program data, if the co-active.
- Q19. Addressable smoke detector has false alarm?
A: 1. Detector is affected by dust.
2. Detector is faulty.
3. Check the loop wire (S terminal) if it is cross-over to other wire.
- Q20. Conventional smoke detector has false alarm?
A: 1. Detector is affected by dust.
2. Detector is faulty.
3. Check the L terminal of module if it is short circuit or ground.
- Q21. Addressable heat detector has false alarm?
A: 1. Detector is faulty.
2. Ambient temperature changes too vary.
3. High humidity.
4. Check the loop wire (S terminal) if it is cross-over to other wire.
- Q22. Conventional heat detector has false alarm?
A: 1. Detector is faulty.
2. Ambient temperature changes too vary.
3. High humidity.
4. Check the L terminal of module if it is short circuit or ground.

Q23. Problem between the QA17-B module and Bell switch, after panel has reset, module (B-/N.O.) does not reset?

A: Module is use magnetic type relay, and it will need high current draw if reset all relays at once after panel reset. So we have to reset module one by one from lower number to high number, the total reset time will not over 30 seconds. Also will suggest that you should first silence the bell from panel then reset the panel.

Q24. Program data could not download or upload between panel and PC?

A: 1. Before start to download (PC to panel), first select download from panel then select download from PC; Before start to upload (panel to PC), first select upload from PC then select upload from panel.
2. Confirm the COM PORT is selected correctly.
3. Confirm the download data cable is connected to JP1 of PCB 05316-2D on switch board.

Q25. Annunciator could not reset fire alarm and review alarm signal?

A: 1. Confirm the annunciator is in normal on-line status, if not refer to Q5.
2. Confirm the annunciator is in normal operation, and refer to Q8 for panel confirmation.

Q26. Isolator module does not work?

A: Isolator connects to panel via IN terminal and connects to loop device via OUT terminal. When isolator detects short circuit or overload on OUT terminal, it will cut-off the IN terminal. First assume that isolator module is normal, connect loop device one by one to check if any of them is faulty to cause the isolator cut-off. When isolator is cut-off, the S+/S- will also shut-off and all connected devices will become faulty.



A series of horizontal lines for writing notes, starting below the header bar and extending to the bottom of the page.



QA16 Addressable System

HORING LIH INDUSTRIAL CO., LTD.